

FLEXIA



Designer : iOL Design



The ultimate platform for your unique urban lighting solution

Various designs, many configurations, one single DNA. FLEXIA is the ultimate platform to create your unique urban lighting solution. Focus on creating a unique ambiance for people living and visiting your spaces instead of dealing with non-stop constraints. With no technical limitations, more design consistency and the guarantee of the latest innovations, FLEXIA offers a versatile technological platform with refined aesthetics. The FLEXIA range incorporates a refined design and state-of-the-art LED technology to provide an energy-efficient lighting solution that enhances city streets while preventing light pollution. Ideal for large boulevards, city centres, public squares, bike paths and other urban outdoor areas, FLEXIA delivers a high-quality lighting with design consistency and lowers the carbon footprint for towns and cities - creating a safe and attractive environment.

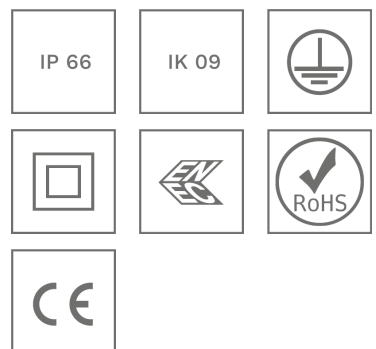

Concept

FLEXIA is a complete urban and decorative platform designed to provide the greatest modularity and easy customisation. FLEXIA Midi is a versatile luminaire, designed for side-entry or suspended mounting. It is composed of an aluminium body sealed with a glass protector while FLEXIA Top provides an aesthetical post-top solution with a polycarbonate protector (also for suspended variants). Various internal aesthetic options such as the Coppa or the Quattro accessories complement the range. FLEXIA offers three different decorative crowns: the Mona as standard and the Lisa or Scala as options. Both the Lisa and Scala crowns can have a customised finish (colour, pattern, texture) to enhance your identity.

FLEXIA Midi and FLEXIA Top are based on the same technical architecture. They both rely on the new LensoFlex^{®4} photometrical engine, developed on a concept of performance, dark-sky compliance (PureNight) and versatility, and both use the same CR-Kit that regroups the LEDs, lenses, gear and electrical accessories on a tool-free removable unit. This standardisation of internal components enables an easier and more cost-effective management of spare parts. To simplify installation, the FLEXIA range is delivered pre-cabled. It also uses the patented IzyHub compact connection and connectivity module which is designed for quick, error-proof wiring.

The FLEXIA luminaires offer tool-free access to the gear compartment. For safety reasons, they include an instant electrical disconnection on opening.

The FLEXIA range is available with various connectivity options (NEMA or Zhaga), sensors and the FlexiWhite solution that adapts the colour temperature of the lighting to the need of the space and the moment. Thanks to tool-free access to the optical compartment, Cromax coloured filters can be added any time to create a special atmosphere for events.

Built with recyclable materials and with an architecture designed for easy service, FLEXIA is a role model for a circular economy.

TYPES OF APPLICATION

- URBAN & RESIDENTIAL STREETS
- BRIDGES
- BIKE & PEDESTRIAN PATHS
- RAILWAY STATIONS & METROS
- SQUARES & PEDESTRIAN AREAS
- ROADS & MOTORWAYS

KEY ADVANTAGES

- State-of-the-art LED modular platform that can be endlessly customised
- Design consistency for all urban applications
- Numerous mounting possibilities (post-top, side-entry and suspended)
- Tool-free philosophy: opening, cabling and LED engine removal
- PureNight: dark-sky and low-glare lighting distributions
- FlexiWhite option for human-centric and nature-friendly scenarios
- Supplied pre-cabled to facilitate its installation
- Smart-city ready (NEMA) and ZD4i compliant (Zhaga)



FLEXIA Top offers a slip-over mounting on Ø60 or Ø76mm spigots. It is also available for suspended variants.



FLEXIA Midi is designed for side-entry mounting with the versatile Sofia bracket, enabling numerous configurations.



FLEXIA includes an instant electrical disconnection on opening and a complete tool-free removable LED engine.



To remain as open and interoperable as possible, FLEXIA is available with both NEMA or Zhaga sockets and complies with the new ZD4i standard.

FLEXIA | Midi | Sofia bracket



FLEXIA | Midi | Evens bracket



FLEXIA | Top



FLEXIA | Midi | suspended with Top protector



FLEXIA | Midi | catenary



FLEXIA | Midi | available crowns



FLEXIA | Midi + Top | with Coppa



FLEXIA | Midi + Top | with Cromia filters





LensoFlex®4

LensoFlex®4 maximises the heritage of the LensoFlex® concept with a very compact yet powerful photometric engine based upon the addition principle of photometric distribution. The number of LEDs in combination with the driving current determines the intensity level of the light distribution. With optimised light distributions and very high efficiency, this fourth generation enables the products to be downsized to meet application requirements with an optimised solution in terms of investment.

LensoFlex®4 optics can feature backlight control to prevent intrusive lighting, or a glare limiter for high visual comfort.

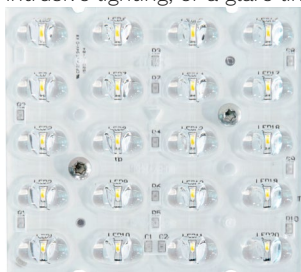

Back Light control

As an option, the LensoFlex®2 and LensoFlex®4 modules can be equipped with a Back Light control system.

This additional feature minimises light spill from the back of the luminaire to avoid intrusive light towards buildings.

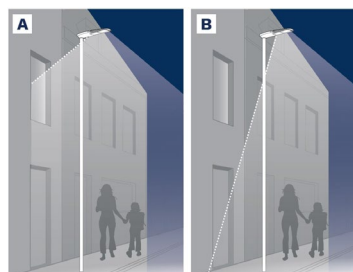

A. Without Back Light control | B. With Back Light control



Custom dimming profile

Intelligent luminaire drivers can be programmed with complex dimming profiles. Up to five combinations of time intervals and light levels are possible. This feature does not require any extra wiring.

The period between switching on and switching off is used to activate the preset dimming profile. The customised dimming system generates maximum energy savings while respecting the required lighting levels and uniformity throughout the night.

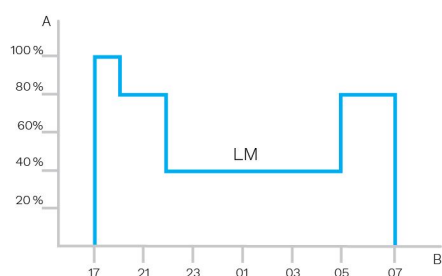

A. Dimming level | B. Time



Daylight sensor / photocell

Photocell or daylight sensors switch the luminaire on as soon natural light falls to a certain level. It can be programmed to switch on during a storm, on a cloudy day (in critical areas) or only at nightfall so as to provide safety and comfort in public spaces.

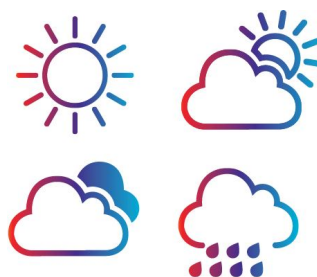

PIR sensor: motion detection

In places with little nocturnal activity, lighting can be dimmed to a minimum most of the time. By using passive infrared (PIR) sensors, the level of light can be raised as soon as a pedestrian or a slow vehicle is detected in the area.

Each luminaire level can be configured individually with several parameters such as minimum and maximum light output, delay period and ON/OFF duration time. PIR sensors can be used in an autonomous or interoperable network.



IzyHub

IzyHub is an innovative device that aims to keep luminaire installation and maintenance hassle-free. This single central connection hub distributes electricity and control information to all parts of the luminaire, ensuring that all components work together and offering reliable, long-term performance.

Its compact size and error-proof connections enable smaller and lighter luminaires that are easier to maintain and upgrade.



Surge Protection

IzyHub features a built-in surge protection device. This prevents electrical surges resulting from lightning strikes and other transient voltages that originate from the mains network from damaging the luminaire, even in the most demanding conditions. The protective device also includes an end-of-life LED warning light, indicating that the luminaire is protected correctly.

User-friendly

Installing a luminaire has never been easier. IzyHub features tool-free connector as the main connection terminal. It enables 30% shorter installation times compared with standard solutions. Lever actuated spring-loaded electrical connectors provide optimal contact throughout the entire life of the product.

Easy maintenance

On the rare occasion that a component needs to be replaced in the luminaire, IzyHub makes sure that operations are carried out quickly and easily. Luminaire component connections are keyed so that mixing up electrical connections is physically impossible. Installers do not need to trace wires individually: plug it in, and it works straight away.



Versions and upgrades

IzyHub has several versions featuring different connectivity. IzyHub can include an SPD, can work with external dimming and operate with all type of control sockets. It is also able to provide bi-power control and to include fuse options.

These options provide flexibility for future upgrades by only having to replace the IzyHub to connect the new equipment. No complicated re-wiring needed.

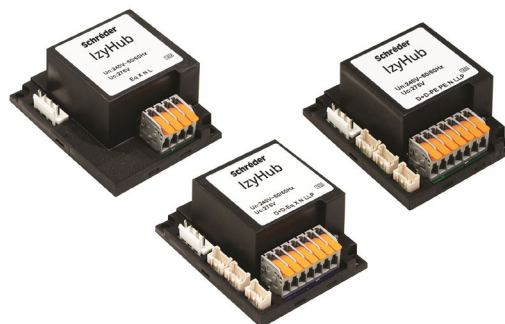

Owlet IoT

Owlet IoT remotely controls luminaires in a lighting network, creating opportunities for improved efficiency, accurate real-time data and energy savings of up to 85%.

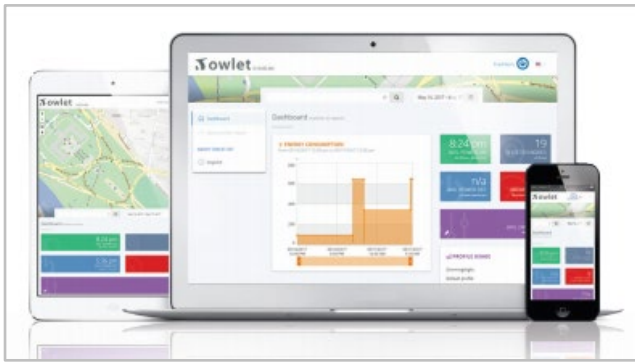

ALL-IN-ONE

The LUCO P7 CM controller includes the most advanced features for optimised asset management. It also provides an integrated photocell and operates with an astronomical clock for seasonal dimming profile adaptations.

EASY TO DEPLOY

Thanks to wireless communication, no cabling is needed. The network is not subject to physical constraints or limitations. From a single control unit to an unlimited network, you can expand your lighting scheme at any time.

With real-time geolocation and automatic detection of luminaire features, commissioning is quick and easy.

USER-FRIENDLY

Once a controller is installed on a luminaire, the luminaire automatically appears with its GPS coordinates on a web-based map.

An easy-to-use dashboard enables each user to organise and customise screens, statistics and reports. Users can gain relevant, real-time insights.

The Owlet IoT web application can be accessed at all times from anywhere in the world with a device connected to the Internet. The application adapts to the device to offer an intuitive and user-friendly experience.

Real-time notifications can be pre-programmed to monitor the most important elements of the lighting scheme.

SECURE

The Owlet IoT system uses a local wireless mesh communication networks to control the on-site luminaires combined with a remote control system utilising the cloud to ensure smooth data transfers to and from the central management system.

The system uses encrypted IP V6 communication to protect data transmission in both directions. Using a secure APN, Owlet IoT ensures a high level of protection.

In the exceptional case of a communication failure, the built-in astronomical clock and photocell will take over to switch the luminaires on and off, thus avoiding a complete blackout at night.

EFFICIENT

Thanks to sensors and/or pre-programmed settings, lighting scenarios can be easily adapted to cope with live events, providing the right lighting levels at the right time and in the right place.

The integrated utility grade meter offers the highest accuracy available on the market today, enabling decisions based on real figures.

Accurate real-time feedback and clear reporting ensures that the network operates efficiently and maintenance is optimised.

When LED luminaires are switched on, the inrush current can create problems for the electricity grid. Owlet IoT incorporates an algorithm to preserve the grid at all times.

OPEN

The LUCO P7 CM controller can be plugged onto the standard 7 pin NEMA socket and operates through either a DALI or 1-10V interface to control the luminaire.

Owlet IoT is based on the IPv6 protocol. This method for addressing devices can generate an almost unlimited number of unique combinations to connect non-traditional components to the Internet or computer network.

Through open APIs, Owlet IoT can be integrated into existing or future global management systems.

The Schröder Bluetooth solution consists of 3 main components:

- A Bluetooth dongle plugged into the modular driver of the luminaire (BLE transceiver)
- A Bluetooth antenna fitted on the luminaire
- A smartphone application called Sirius BLE



Easy to use

The Schröder Bluetooth solution is ideal for the on-site configuration of individual outdoor luminaires using Bluetooth. From the ground, the user is able to switch the luminaire on or off, adapt the dimming curve, read diagnostic data and much more. A user-friendly application called Sirius BLE provides an easy and secure access to the control and configuration functions.

Whether you are managing a lighting network in an urban or a residential area, this solution will make it easy to control your outdoor luminaires while simply standing by the pole.

Quick and easy pairing

Get the Sirius App from Schröder. Go to the menu. Press the “SCAN DEVICE (START)” button, to search for the surrounding BLE modules. They will be displayed with a bar graphic (signal intensity) to indicate the closest and the most distant one you can reach. Click on the device you want to connect to and enter your personal access key to control the luminaire.



Defining the settings

Once you are connected to a luminaire, you can set various parameters such as the maximum output current, minimum dimming level and custom dimming profile.

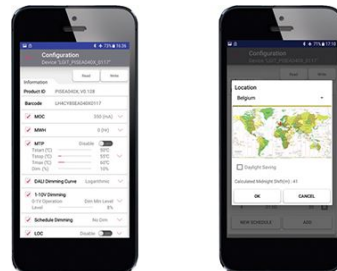

Manual dimming control

The App enables you to do a manual override to adapt the dimming levels instantly. Simply tap on the “Dimming” button in the main menu and adjust the dimming using the wheel and button. Predefined dimming levels can be applied immediately. The corresponding value is displayed on the wheel. This enables you to test the ON / OFF and dimming features of the luminaire paired to the smartphone.



On-site diagnostic

When a luminaire is paired, you can access various diagnostic information: total number of power up events, operation time of LED module and driver, total energy consumption of LED driver... etc. You can also track operating events (short circuits, thermal shutdowns...). The diagnostic values may be the current state or values accumulated to date.

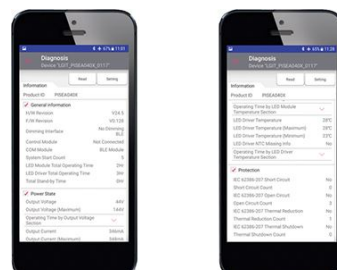

GENERAL INFORMATION

Recommended installation height	4m to 12m 13' to 39'
FutureProof	Easy replacement of the photometric engine and electronic assembly on-site
Circle Light label	Score >90 - The product fully meets circular economy requirements
Driver included	Yes
CE Mark	Yes
CB Mark	Yes
ENEC certified	Yes
ROHS compliant	Yes
French law of December 27th 2018 - Compliant with application type(s)	a, b, c, d, e, f, g
Testing standard	LM 79-08 (all measurements in ISO17025 accredited laboratory)

HOUSING AND FINISH

Housing	Aluminium
Optic	PMMA
Protector	Tempered glass Polycarbonate
Housing finish	Polyester powder coating
Standard colour(s)	AKZO grey 900 sanded
Tightness level	IP 66
Impact resistance	IK 09
Vibration test	Compliant with modified IEC 68-2-6 (0.5G)
Access for maintenance	Tool-less access to gear compartment

· Any other RAL or AKZO colour upon request

OPERATING CONDITIONS

Operating temperature range (Ta)	-40 °C up to +55 °C / -40 °F up to 131 °F with wind effect
----------------------------------	--

· Depending on the luminaire configuration. For more details, please contact us.

ELECTRICAL INFORMATION

Electrical class	Class I EU, Class II EU
Nominal voltage	220-240V – 50-60Hz
Power factor (at full load)	0.95+
Surge protection options (kV)	10
Electromagnetic compatibility (EMC)	EN 55015 / EN 61000-3-2 / EN 61000-4-5 / EN 61547
Control protocol(s)	Bluetooth, 1-10V, DALI
Control options	AmpDim, Bi-power, Custom dimming profile, Photocell, Remote management
Socket	NEMA 7-pin (optional) Optional Zhaga socket - ZD4i certified product
Associated control system(s)	Sirius BLE Owlet IoT
Sensor	PIR (optional)

OPTICAL INFORMATION

LED colour temperature	2200K (FlexiWhite 722) 2600K (FlexiWhite 726) 2700K (Warm White 727) 3000K (Warm White 730) 3000K (Warm White 830) 3000K (FlexiWhite 730) 4000K (Neutral White 740)
Colour rendering index (CRI)	>70 (FlexiWhite 722) >70 (FlexiWhite 726) >70 (Warm White 727) >70 (Warm White 730) >80 (Warm White 830) >70 (FlexiWhite 730) >70 (Neutral White 740)
Upward Light Output Ratio (ULOR)	0%

· ULOR may be different according to the configuration. Please consult us.

LIFETIME OF THE LEDS @ TQ 25°C

All configurations	100,000h - L95
--------------------	----------------

DIMENSIONS AND MOUNTING

AxBxC (mm inch)	FLEXIA TOP - 504x752x504 19.8x29.6x19.8 FLEXIA MIDI - 504x140x504 19.8x5.5x19.8
Weight (kg lbs)	FLEXIA TOP - 10 22.0 FLEXIA MIDI - 9.6 21.1
Aerodynamic resistance (CxS)	FLEXIA TOP - 0.11 FLEXIA MIDI - 0.11
Mounting possibilities	Side-entry slip-over – Ø60mm Side-entry penetrating – Ø48mm Post-top slip-over – Ø60mm Post-top slip-over – Ø76mm Suspended 1" gas male Suspended 1" gas female Catenary Wall-mounted

· Various dedicated brackets, swivelling and direct mountings. Please consult the installation sheets.

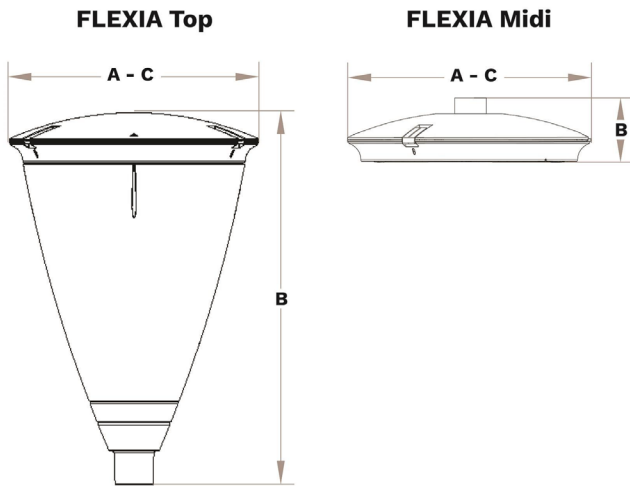



	Number of LEDs	mA	Luminaire output flux (lm) Warm White 727		Luminaire output flux (lm) Warm White 730		Luminaire output flux (lm) Warm White 830		Luminaire output flux (lm) FlexiWhite 722		Luminaire output flux (lm) Neutral White 740		Luminaire output flux (lm) FlexiWhite 726		Luminaire output flux (lm) FlexiWhite 730		W	lm/W	Photometry
			Min	Max	Min	Max	Min	Max	Min	Max	Min	Max	Min	Max	Min	Max			
FLEXIA TOP	10	200	700	800	700	900	700	800	600	700	800	900	-	-	-	-	7.4	122	
	10	300	1000	1200	1100	1300	1000	1200	800	1000	1100	1300	-	-	-	-	10.5	124	
	10	300	-	-	-	-	-	-	800	1000	-	-	900	1100	1000	1200	10.7	112	
	10	400	1300	1600	1400	1700	1300	1600	1100	1300	1500	1700	-	-	-	-	13.8	123	
	10	400	-	-	-	-	-	-	1100	1300	-	-	1200	1500	1300	1600	13.9	115	
	10	500	1600	1900	1700	2000	1600	1900	1300	1600	1800	2100	-	-	-	-	17.2	122	
	10	500	-	-	-	-	-	-	1300	1600	-	-	1500	1800	1600	1900	17.1	111	
	10	600	1800	2200	2000	2300	1800	2200	1500	1800	2100	2500	-	-	-	-	20.5	122	
	10	600	-	-	-	-	-	-	1500	1800	-	-	1700	2100	1900	2200	20.5	107	
	10	650	2000	2300	2100	2500	2000	2300	1600	2000	2200	2600	-	-	-	-	22.2	117	
	10	700	-	-	-	-	-	-	1800	2200	-	-	2000	2400	2200	2600	23.8	109	
	10	750	-	-	-	-	-	-	1900	2300	-	-	2200	2600	2300	2800	25.2	111	
	20	200	1400	1700	1500	1800	1400	1700	1200	1400	1600	1900	-	-	-	-	13.5	141	
	20	200	-	-	-	-	-	-	1200	1400	-	-	1300	1600	1400	1700	13.5	126	
	20	300	2000	2400	2200	2600	2000	2400	1700	2100	2300	2700	-	-	-	-	19.6	138	
	20	300	-	-	-	-	-	-	1700	2000	-	-	1900	2300	2100	2500	19.5	128	
20	400	2600	3200	2800	3400	2600	3200	2200	2700	3000	3500	-	-	-	-	26	135		

Tolerance on LED flux is ± 7% and on total luminaire power ± 5 %



	Number of LEDs	mA	Luminaire output flux (lm) Warm White 727		Luminaire output flux (lm) Warm White 730		Luminaire output flux (lm) Warm White 830		Luminaire output flux (lm) FlexiWhite 722		Luminaire output flux (lm) Neutral White 740		Luminaire output flux (lm) FlexiWhite 726		Luminaire output flux (lm) FlexiWhite 730		W	lm/W	Photometry
			Min	Max	Min	Max	Min	Max	Min	Max	Min	Max	Min	Max	Min	Max			
FLEXIA TOP	20	400	-	-	-	-	-	-	2200	2700	-	-	2500	3000	2700	3200	25.7	125	
	20	500	3200	3800	3400	4100	3200	3800	2700	3200	3600	4300	-	-	-	-	32.6	132	
	20	500	-	-	-	-	-	-	2700	3300	-	-	3100	3700	3300	3900	32.2	121	
	20	600	3700	4400	4000	4700	3700	4400	3100	3700	4200	5000	-	-	-	-	39.2	128	
	20	600	-	-	-	-	-	-	3200	3800	-	-	3600	4300	3900	4600	38.6	119	
	20	700	-	-	-	-	-	-	3700	4400	-	-	4100	4900	4400	5300	45	118	
	20	800	-	-	-	-	-	-	4100	4900	-	-	4600	5500	4900	5900	51.5	115	
	20	900	-	-	-	-	-	-	4500	5400	-	-	5000	6000	5400	6500	58	112	
	20	1000	-	-	-	-	-	-	4900	5800	-	-	5500	6500	5900	7000	64.5	109	
	40	200	3000	3300	3200	3500	3000	3300	2500	2800	3400	3700	-	-	-	-	25.5	152	
	40	300	4400	4800	4700	5100	4400	4800	3700	4000	4900	5400	-	-	-	-	37.6	146	
	40	350	4800	5700	5100	6000	4800	5700	4000	4800	5300	6400	-	-	-	-	43.5	149	
	40	500	6800	7500	7300	7900	6800	7500	5800	6300	7700	8400	-	-	-	-	62.5	134	
	40	600	7500	8900	8000	9500	7500	8900	6300	7500	8400	10000	-	-	-	-	75	133	
	40	700	8400	10000	9000	10700	8400	10000	7100	8500	9500	11300	-	-	-	-	89	127	

Tolerance on LED flux is ± 7% and on total luminaire power ± 5 %



	Number of LEDs	mA	Luminaire output flux (lm) Warm White 727		Luminaire output flux (lm) Warm White 730		Luminaire output flux (lm) Warm White 830		Luminaire output flux (lm) FlexiWhite 722		Luminaire output flux (lm) Neutral White 740		Luminaire output flux (lm) FlexiWhite 726		Luminaire output flux (lm) FlexiWhite 730		W	lm/W	Photometry
			Min	Max	Min	Max	Min	Max	Min	Max	Min	Max	Min	Max	Min	Max			
FLEXIA MIDI	10	200	800	800	800	900	800	800	-	-	900	900	-	-	-	-	7.4	122	
	10	300	1100	1200	1200	1300	1100	1200	-	-	1300	1400	-	-	-	-	10.5	133	
	10	300	-	-	-	-	-	-	1000	1000	-	-	1100	1200	1200	1200	10.7	112	
	10	400	1500	1600	1600	1700	1500	1600	-	-	1600	1800	-	-	-	-	13.8	130	
	10	400	-	-	-	-	-	-	1300	1300	-	-	1500	1500	1600	1600	13.9	115	
	10	500	1800	2000	1900	2100	1800	2000	-	-	2000	2200	-	-	-	-	17.2	128	
	10	500	-	-	-	-	-	-	1600	1700	-	-	1800	1900	2000	2000	17.1	117	
	10	600	2100	2300	2200	2400	2100	2300	-	-	2300	2600	-	-	-	-	20.5	127	
	10	600	-	-	-	-	-	-	1900	1900	-	-	2100	2100	2200	2300	20.5	112	
	10	650	2200	2400	2300	2600	2200	2400	-	-	2500	2700	-	-	-	-	22.2	122	
	10	700	-	-	-	-	-	-	2200	2200	-	-	2400	2500	2600	2700	23.8	113	
	10	750	-	-	-	-	-	-	2300	2400	-	-	2600	2600	2800	2800	25.2	111	
	20	200	1600	1700	1700	1800	1600	1700	-	-	1800	1900	-	-	-	-	13.5	141	
	20	200	-	-	-	-	-	-	1400	1400	-	-	1600	1600	1700	1700	13.5	126	
	20	300	2300	2500	2400	2700	2300	2500	-	-	2600	2800	-	-	-	-	19.6	143	
	20	300	-	-	-	-	-	-	2100	2100	-	-	2300	2400	2500	2500	19.5	128	
20	400	3000	3300	3200	3500	3000	3300	-	-	3300	3700	-	-	-	-	26	142		

Tolerance on LED flux is ± 7% and on total luminaire power ± 5 %



	Number of LEDs	mA	Luminaire output flux (lm) Warm White 727		Luminaire output flux (lm) Warm White 730		Luminaire output flux (lm) Warm White 830		Luminaire output flux (lm) FlexiWhite 722		Luminaire output flux (lm) Neutral White 740		Luminaire output flux (lm) FlexiWhite 726		Luminaire output flux (lm) FlexiWhite 730		W	lm/W	Photometry
			Min	Max	Min	Max	Min	Max	Min	Max	Min	Max	Min	Max	Min	Max			
FLEXIA MIDI	20	400	-	-	-	-	-	-	2700	2700	-	-	3000	3100	3200	3300	25.7	128	
	20	500	3600	4000	3800	4200	3600	4000	-	-	4000	4500	-	-	-	-	32.6	138	
	20	500	-	-	-	-	-	-	3300	3400	-	-	3700	3800	4000	4100	32.2	127	
	20	600	4200	4600	4400	4900	4200	4600	-	-	4700	5200	-	-	-	-	39.2	133	
	20	600	-	-	-	-	-	-	3900	3900	-	-	4300	4400	4600	4800	38.6	124	
	20	700	-	-	-	-	-	-	4400	4500	-	-	4900	5000	5300	5400	45	120	
	20	800	-	-	-	-	-	-	4900	5000	-	-	5500	5600	5900	6000	51.5	117	
	20	900	-	-	-	-	-	-	5400	5500	-	-	6000	6200	6500	6600	58	114	
	20	1000	-	-	-	-	-	-	5800	6000	-	-	6500	6700	7000	7200	64.5	112	
	40	200	3200	3500	3400	3700	3200	3500	-	-	3600	3900	-	-	-	-	25.5	160	
	40	300	4600	5100	4900	5400	4600	5100	-	-	5200	5700	-	-	-	-	37.6	154	
	40	350	5300	5900	5700	6300	5300	5900	-	-	6000	6600	-	-	-	-	43.5	153	
	40	400	6000	6600	6400	7000	6000	6600	-	-	6700	7400	-	-	-	-	50	148	
	40	500	7200	8000	7700	8500	7200	8000	-	-	8100	9000	-	-	-	-	62.5	144	
	40	600	8400	9300	8900	9900	8400	9300	-	-	9400	10400	-	-	-	-	75	139	
	40	700	9400	10400	10100	11100	9400	10400	-	-	10600	11700	-	-	-	-	89	131	

Tolerance on LED flux is ± 7% and on total luminaire power ± 5 %

